



Infrared temperature measuring instrument

testo 830 – Fast, non-contact measurement of surface temperature

Laser measurement point marker and large optics for exact measurement even at greater distances

Fast recording of measurement values at two measurements per second

Adjustable emissivity

Two adjustable alarm limit values

Good handling thanks to ergonomic „pistol design“

Hold function and display of min./max. values



The testo 830 is a universally applicable infrared thermometer for non-contact measurement of surface temperatures in trade and industry. Thanks to a new processor, and therefore better resolution, even more precise measurements are now possible. Temperature can now be recorded to an accuracy of 0.1 °C. Thanks to the min./max. function, the limit values of the last measurement can be displayed and even better monitored.

The testo 830 infrared thermometer in brief:

- testo 830-T1 with 1-point laser measurement spot marking and 10:1 optics.
- testo 830-T2 with 2-point laser measurement spot marking and 12:1 optics.
- testo 830-T4 with 2-point laser measurement spot marking and 30:1 optics. This instrument measures the surface temperature even of smaller objects at a safe distance. External temperature probes can be connected.



Infrared temperature measuring instruments

testo 830

Infrared thermometer with 1-point laser sighting

testo 830-T1

testo 830-T1, infrared thermometer, 1 point laser sighting, 10:1 optics, adjustable limit values, alarm function, incl. Batteries and calibration protocol

Part no. 0560 8311



Infrared thermometer with 2-point laser sighting and connection for external probes

testo 830-T2

testo 830-T2, infrared thermometer, 2-point laser sighting, 12:1 optics, adjustable limit values, alarm function, connection of external probes, incl. Batteries and calibration protocol

Part no. 0560 8312



The fast and universal infrared thermometer with 1-point laser sighting and 10:1 optics in ergonomic „pistol design“.

- Fast readings
- Laser sighting
- Adjustable alarm limits
- Audible and visual alarm if limits are exceeded
- User-friendly thanks to „pistol design“
- Backlit display
- Adjustable emission factor (0.1 to 1.0)

testo 830-T2 Set

Set testo 830-T2, infrared thermometer with protective leather case, incl. cross-band surface probe (0602 0393), Batteries and calibration protocol

Part no. 0563 8312

This universal infrared thermometer is designed to perform fast and accurate surface temperature measurements in the HVAC area and industry. The new high resolution processor enables measurement results of unbelievable accuracy. Thanks to the min./max. function you can define your temperature limit values according to your needs. To control the limits with the help of an audible and visual alarm has never been easier.

In addition to the benefits of testo 830-T1:

- 2-point laser sighting
- Contact measurement with connectable temperature probe
- Emissivity determination with external TC probe



Infrared temperature measuring instruments

testo 830

Infrared thermometer with 30:1 optics for exact measurement at a distance

testo 830-T4

testo 830-T4, infrared thermometer, 2-point laser sighting, 30:1 optic, adjustable limit values, alarm function, connection of external probes, incl. Batteries and calibration protocol

Part no. 0560 8314



Set testo 830-T4

Set testo 830-T4, infrared thermometer with protective leather case, incl. cross-band surface probe (0602 0393), battery and calibration protocol

Part no. 0563 8314

This universal infrared thermometer is designed to perform fast and accurate surface temperature measurements in the HVAC area and industry. At a distance of 1 m the point diameter is only 3.6 cm. From a secure distance even smaller, difficult to access or dangerous targets can be measured without any problems. The new high resolution processor enables measurement results of unbelievable accuracy. And due to the min./max. function you can define your temperature limit values according to your needs. To control the limits with the help of an audible and visual alarm has never been easier.

- 30:1 optics for measuring temperature at a distance, even on small objects
- °C contact measurement with connectable TC probe
- Emissivity determination with external temperature probe
- Input of upper and lower limit value
- Audible and optical alarm when limit values are exceeded
- Display illumination



Technical data

Common technical data for all versions

Spectral range	8 to 14 μm
Emissivity	Adjustable 0.1 to 1.0
Storage temperature	-40 to +70 °C
Operating temperature	-20 to +50 °C

Battery type	9V block battery
Battery life	15 h
Weight	200 g
Dimensions	190 x 75 x 38 mm
Housing material	ABS

Varying technical data

	testo 830-T1	testo 830-T2	testo 830-T4
Measuring range			
Infrared	-30 to +400 °C	-30 to +400 °C	-30 to +400 °C
Type K (NiCr-Ni)	-	-50 to +500 °C	-50 to +500 °C
Accuracy ± 1 digit			
Infrared	± 1.5 °C or 1.5 % of m.v. (+0.1 to +400 °C) ± 2 °C or ± 2 % of m.v. (-30 to 0 °C) the higher value applies	± 1.5 °C or ± 1.5 % of m.v. (+0.1 to +400 °C) ± 2 °C or ± 2 % of m.v. (-30 to 0 °C) the higher value applies	± 1.5 °C (-20 to 0 °C) ± 2 °C (-30 to -20,1 °C) ± 1 °C or 1 % of m.v. (remaining range)
Type K (NiCr-Ni)	-	± 0.5 °C +0.5% of m.v.	± 0.5 °C +0.5% of m.v.
Resolution	0.1 °C	0.1 °C	0.1 °C
Measurement rate			
Infrared	0.5 s	0.5 s	0,5 s
Type K (NiCr-Ni)	-	1.75 s	1.75 s
Meas. spot marking	1-point laser	2-point laser	2-point laser
Distance to measurement spot	10:1	12:1	30:1 (typical at a distance of 0.7 m to the measurement object 24 mm @ 700 mm (90%))



Optics

testo 830-T1

**10:1 standard optics,
1 laser beam for spot sighting**

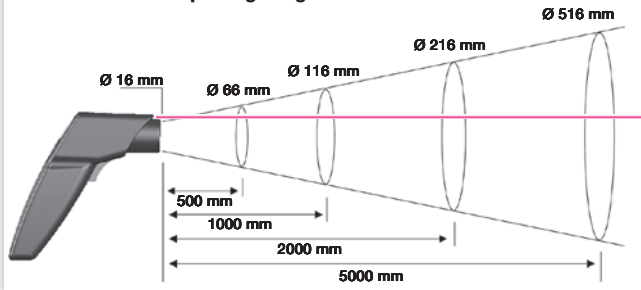

testo 830-T2

Accurate 12:1 optics enable accurate measurements over great distances, 2 laser beams for sighting

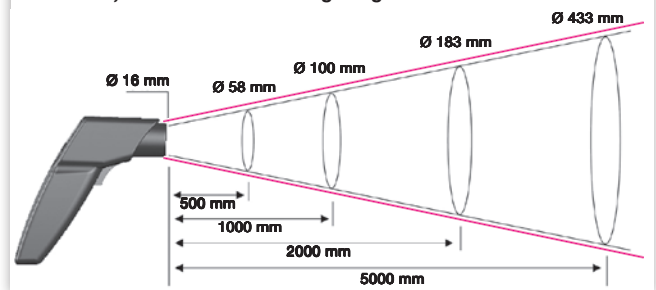

testo 830-T4

**Distance to measurement spot 30:1,
2 laser beams for sighting**

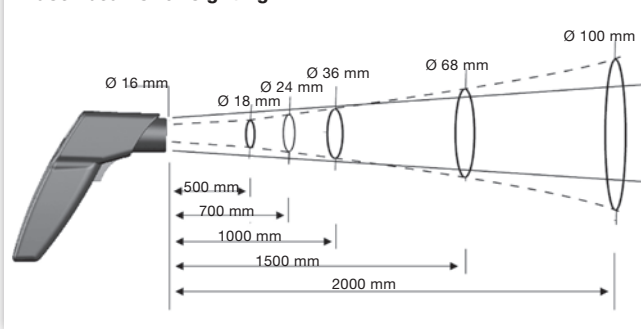

Accessories

Accessories for all testo 830 versions

Part no.







Adhesive tape, e.g. for reflective surfaces (roll, L.: 10 m, W.: 25 mm), $\epsilon = 0.95$, temperature resistant to +250 °C	0554 0051	
Leather case to protect measuring instrument, including belt holder	0516 8302	
9V rech. battery for instrument, instead of battery	0515 0025	
ISO calibration certificate/temperature, infrared thermometer; calibration points +60°C; +120°C; +180°C	0520 0002	

Accessories for testo 830-T2 / -T4

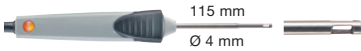
ISO calibration certificate/temperature, meas. instr. with surface probe; calibration points +60°C; +120°C; +180°C	0520 0071	
ISO calibration certificate/temperature, for air/immersion probes, calibration point +60°C	0520 0063	
ISO calibration certificate/temperature, for air/immersion probes, calibration points -18°C; 0°C; +60°C	0520 0001	
ISO calibration certificate/temperature, meas. instr. with air/immersion probe; cal. points 0°C; +150°C; +300°C (Applies only to immersion/penetration probe 0602 2693)	0520 0021	

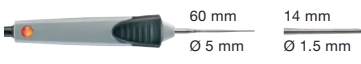
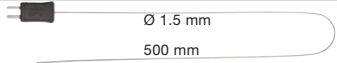
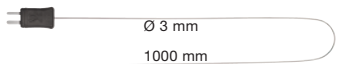
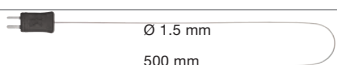
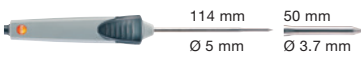

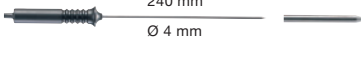
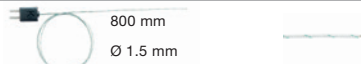





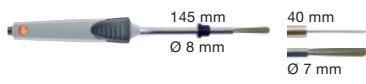
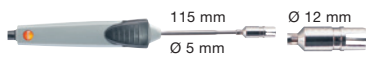
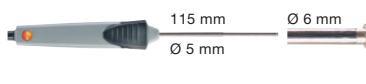

Probes testo 830-T2 / -T4

Probe type	Dimensions Probe shaft/probe shaft tip	Measuring range	Accuracy	t ₉₉	Part no.
Air probes					
Robust air probe, T/C Type K, Fixed cable 1.2 m	 115 mm Ø 4 mm	-60 to +400 °C	Class 2*	200 s	0602 1793
Immersion/penetration probes					
Efficient and fast-action immersion probe, waterproof, TC Type K, Fixed cable 1.2 m	 300 mm Ø 1.5 mm	-60 to +1000 °C	Class 1*	2 s	0602 0593
Fast-action, waterproof immersion/penetration probe, TC Type K (Calibration not possible over +300 °C), Fixed cable 1.2 m	 60 mm 14 mm Ø 5 mm Ø 1.5 mm	-60 to +800 °C	Class 1*	3 s	0602 2693
Immersion tip, flexible, TC Type K	 Ø 1.5 mm 500 mm	-40 to +1000 °C	Class 1*	5 s	0602 5792
Immersion measurement tip, flexible, for measurements in air/exhaust gases (not suitable for measurements in smelters), TC Type K	 Ø 3 mm 1000 mm	-200 to +1000 °C	Class 1*	4 s	0602 5693
Immersion tip, flexible, TC Type K	 Ø 1.5 mm 500 mm	-40 to +40 °C	Class 3*	5 s	0602 5793
Waterproof immersion/penetration probe, TC Type K, Fixed cable 1.2 m	 114 mm 50 mm Ø 5 mm Ø 3.7 mm	-60 to +400 °C	Class 2*	7 s	0602 1293
Food probes					
Waterproof food probe made of stainless steel (IP65), TC Type K, Fixed cable	 125 mm 30 mm Ø 4 mm Ø 3.2 mm	-60 to +400 °C	Class 2*	7 s	0602 2292
Waterproof robust immersion/penetration probe with metal protection hose Tmax +230°C, e.g. for monitoring temp. in cooking oil, T/C Type K, Fixed cable	 240 mm Ø 4 mm	-50 to +230 °C	Class 1*	15 s	0628 1292
Thermocouples					
Thermocouple with TC adapter, flexible, 800 mm long, fibre glass, TC Type K	 800 mm Ø 1.5 mm	-50 to +400 °C	Class 2*	5 s	0602 0644
Thermocouple with TC adapter, flexible, length 1500 mm, fibreglass, TC Type K	 1500 mm Ø 1.5 mm	-50 to +400 °C	Class 2*	5 s	0602 0645
Thermocouple with TC adapter, flexible, 1500 mm long, PTFE, TC Type K	 1500 mm Ø 1.5 mm	-50 to +250 °C	Class 2*	5 s	0602 0646

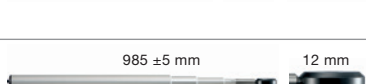
*According to standard EN 60584-1, the accuracy of Class 1 refers to -40 to +1000 °C (Type K), Class 2 to -40 to +1200 °C (Type K), Class 3 to -200 to +40 °C (Type K)

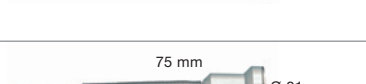

Probes testo 830-T2 / -T4

Probe type	Dimensions Probe shaft/probe shaft tip	Measuring range	Accuracy	t ₉₉	Part no.
Surface probes					
Fast-reaction paddle surface probe, for measurements in inaccessible places, e.g. narrow apertures and slots, TC Type K, Fixed cable		0 to +300 °C	Class 2*	5 s	0602 0193
Fast-action surface probe with sprung thermocouple strip, also for uneven surfaces, measurement range short-term to +500°C, TC Type K, Fixed cable 1.2 m		-60 to +300 °C	Class 2*	3 s	0602 0393
Waterproof surface probe with widened measurement tip for flat surfaces, T/C Type K, Fixed cable 1.2 m		-60 to +400 °C	Class 2*	30 s	0602 1993
Fast-action surface probe with sprung thermocouple strip, bent, also for uneven surfaces, measurement range short-term to +500°C, TC Type K, Fixed cable 1.2 m		-60 to +300 °C	Class 2*	3 s	0602 0993
Efficient, waterproof surface probe with small measurement head for flat surfaces, TC Type K, Fixed cable 1.2 m		-60 to +1000 °C	Class 1*	20 s	0602 0693
Flat head surface probe with telescopic handle max. 680 mm for measurements at hard-to-access points, TC Type K, Fixed cable, 1.6 m (correspondingly shorter when telescope extended)		-50 to +250 °C	Class 2*	3 s	0602 2394
Magnetic probe, adhesive force approx. 20 N, with magnets, for measurements on metal surfaces, TC Type K, Fixed cable		-50 to +170 °C	Class 2*	150 s	0602 4792
Magnetic probe, adhesive force approx. 10 N, with magnets, for higher temp., for measurements on metal surfaces, TC Type K, Fixed cable		-50 to +400 °C	Class 2*		0602 4892
Pipe wrap probe with velcro strip; for temperature measurement on pipes with diameter up to max. 120 mm; Tmax. +120 °C; TC Type K, Fixed cable		-50 to +120 °C	Class 1*	90 s	0628 0020
Pipe wrap probe for pipe diameter 5 to 65 mm, with exchangeable measuring head. Meas. range short-term up to +280 °C, TC Type K, Fixed cable		-60 to +130 °C	Class 2*	5 s	0602 4592
Spare meas. head for pipe wrap probe, TC Type K		-60 to +130 °C	Class 2*	5 s	0602 0092
Clamp probe for measurements on pipes, pipe diameter 15 to 25 mm (max. 1"), meas. range short-term up to +130°C, TC Type K, Fixed cable		-50 to +100 °C	Class 2*	5 s	0602 4692

*According to standard EN 60584-1, the accuracy of Class 1 refers to -40 to +1000 °C (Type K), Class 2 to -40 to +1200 °C (Type K), Class 3 to -200 to +40 °C (Type K)